

### 5/2-Way, Hand Lever Manually Actuated Valve Thread-G3/8

HLV510-S Single

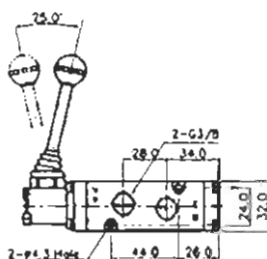

HLV520-D Double

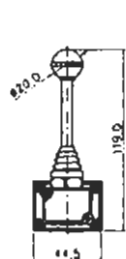
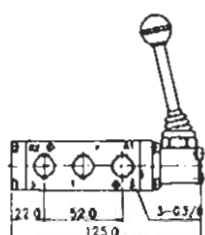
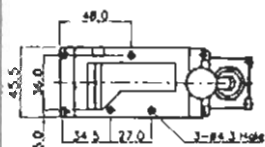
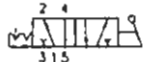

### 5/3-Way, Hand Lever Manually Actuated Valve Thread-G3/8

HLV530-S Closed Center

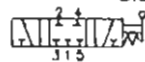

HLV530-D Closed Center



HLV540-S Exhaust Center



HLV540-D Exhaust Center

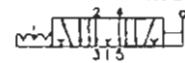

HLV550-S Pressure Center



HLV550-D Pressure Center

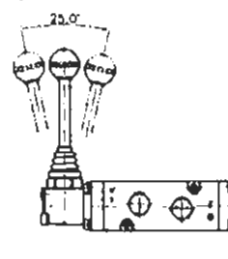
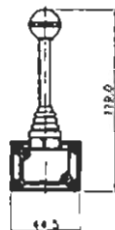
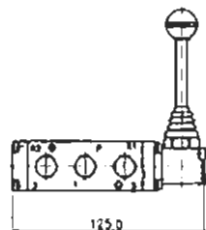

### 3/2-Way, Hand Lever Manually Actuated Valve Thread-G3/8

HLV580-S Single

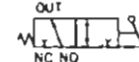

HLV580-D Double

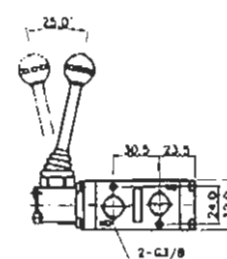
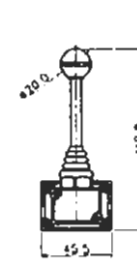
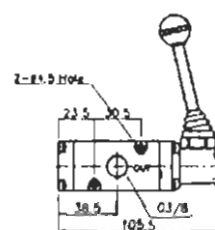
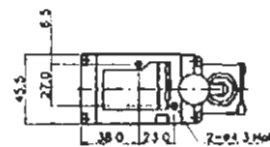
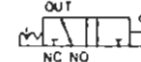

### 5/2-Way, Hand Lever Manually Actuated Valve Thread-G1/2

HLV610-S Single

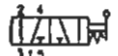

HLV620-D Double

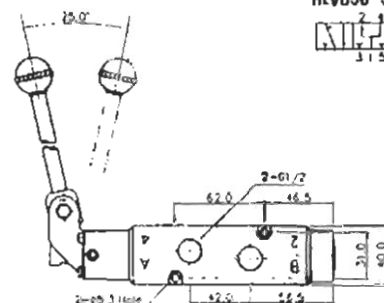
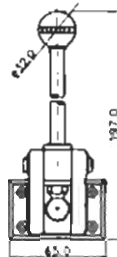
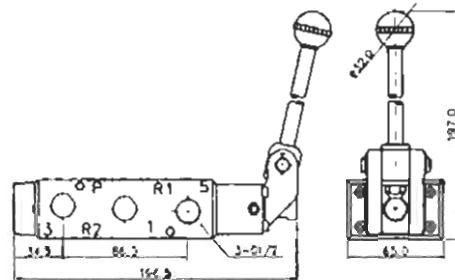
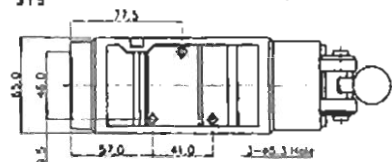

### 5/3-Way, Hand Lever Manually Actuated Valve Thread-G1/2

HLV630-S Closed Center

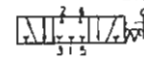

HLV630-D Closed Center



HLV640-S Exhaust Center



HLV640-D Exhaust Center



HLV650-S Pressure Center



HLV650-D Pressure Center

